

# Operating Instructions

Model:  
JG PRT-E

*This is a multi mode thermostat,  
please see page 13 for setup instructions*



# Contents Page

What is a programmable thermostat?	2-4
Installation	5-6
Icons explained	6
Temperature Display	7
Setting the Clock	7
Setting the Comfort Levels	8-9
Keypad Lock Facility	9
Temperature Hold	10
Setting the Temperature	10
Holiday Feature	11
Turning the Heating On/Off	12
Factory Reset	12
Setting the Mode	13
Optional Thermostat Settings	14-19
Wiring	20-21

## **What is a programmable room thermostat?**

A programmable room thermostat is both a programmer and a room thermostat. A programmer allows you to set “On” and “Off” periods to suit your own lifestyle. A room thermostat works by sensing the air temperature, switching on the heating when the air temperature falls below the thermostat setting, and switching it off once this set temperature has been reached.

So, a programmable room thermostat lets you choose what times you want the heating to be on, and what temperature it should reach while it is on. It will allow you to select different temperatures in your home at different times of the day (and days of the week) to meet your particular needs.

Turning a programmable room thermostat to a higher setting will not make the room heat up any faster. How quickly the room heat up depends on the design of the heating system, the size of the boilers and radiators.

Neither does the setting affect how quickly the room cools

down. Turning a programmable room thermostat to a lower setting will result in the room being controlled at a lower temperature, and saves energy.

The way to set and use your programmable room thermostat is to find the lowest temperature settings that you are comfortable with at the different times you have chosen, and then leave it alone to do its job.

The way to set and use your programmable room thermostat is to find the lowest temperature setting you are comfortable with, and then leave it alone to do its job. The best way to do this is to set the room thermostat to a low temperature – say 18°C – and then turn it up by 1°C each day until you are comfortable with the temperature. You won't have to adjust the thermostat further. Any adjustment above this setting will waste energy and cost you more money.

If your heating system is a boiler with radiators, there will usually be only one programmable room thermostat to control the whole house. But you can have different temperatures in individual rooms by installing thermostatic radiator valves

(TRVs) on individual radiators. If you don't have TRVs, you should choose a temperature that is reasonable for the whole house. If you do have TRVs, you can choose a slightly higher setting to make sure that even the coldest room is comfortable, then prevent any overheating in other rooms by adjusting the TRVs. The time on the programmer must be correct. Some types have to be adjusted in spring and autumn at the changes between Greenwich Mean Time and British Summer Time.

You may be able to temporarily adjust the heating programme, for example, "Override", "Advance" or "Boost". These are explained in the manufacturers instructions.

Programmable room thermostats need a free flow of air to sense the temperature, so they must not be covered by curtains or blocked furniture. Nearby electric fires, televisions, wall or table lamps may prevent the thermostat from working properly.

## Installation Procedure

### Do's

1. Do mount the thermostat at eye level.
2. Do read the instructions fully so that you can get the best from our product.

### Don'ts

1. Do not install near a direct heat source as this will affect the workings of the thermostat.
2. Do not push hard on the LCD otherwise you will damage the liquid crystal display and this is not repairable.

## Installation

The thermostat is designed to be flush mount, a back box of 35mm should have been sunk in the wall prior to installation.

### Step 1

Carefully separate the front half of the thermostat from the back plate by placing a small flat head terminal driver in to the slots on the bottom face of the thermostat.





## Step 2

Place the thermostat front somewhere safe. Terminate the thermostat as shown in the diagrams at the back of this booklet.

## Step 3

Clip the front of the thermostat to the back plate.

### Icons Explained

Symbol	Description
	<b>Heat On Icon</b> <i>Shown when the heating is On Flashing when the optimum starts is in operation</i>
	<b>Frost On Icon (Heating Off)</b> <i>Shown when the heating is switched off and is protecting against frost only</i>
	<b>Keylock Icon</b> <i>Shown when the keypad is locked</i>
	<b>Floor Set Temperature Icon</b> <i>Shown when the floor set temperature is reached</i>

## Temperature Display

**Room Temp** = This is the current room temperature.

**SET** = This is the temperature you are trying to achieve in your home.

## Setting the Clock

To set the clock, follow the steps below:

- With the thermostat turned on, press the Clock button twice.
- You are now able to set the minutes using the Up/Down keys.
- Press H to accept.
- You are now able to set the hours using the Up/Down keys.
- Press H to accept.
- You are now able to set the day of the week using the Up/Down keys.
- Press A to store and exit.

## Comfort Levels Explained

The PRT-E provides Weekday/Weekend or 7 Day Programming. You should consult the “Configuration Menu” section to select the required mode.

The thermostat is supplied with comfort levels already programmed, but these can be changed easily. The default times are:

08.00 - 21°C (Wake)

09.30 - 16°C (Leave)

16.30 - 22°C (Return)

23.00 - 17°C (Sleep)

If you only want to use 2 levels, you should program the unused levels to --.--

- To begin programming the comfort levels, press Clock Once.
- If your thermostat is setup for Weekday/Weekend Programming, you will see Mon-Fri shown. For 7 day programming you will see Monday.
- Using the Up/Down arrow keys, enter the required Wake time.

- Press H.
- Using the Up/Down arrow keys, enter the required Wake Temperature.
- Press H.
- You will now see “Leave”.
- You should repeat the programming for each period, entering --. — for unused periods.

Note: For weekday/weekend Programming, the 4 comfort levels are the same for all weekdays. For 7 day programming, each day can have 4 different comfort levels.

### **Locking The Thermostat**

The thermostat has a key-lock facility. To enable follow these steps:

- Press and hold the A and Down Key for 10 seconds.
- You will see the lock symbol appear.
- To unlock, repeat the steps above.

## **Temperature Hold**

The temperature hold function is ideal for parties or when you will be going out for a number of hours. It allows you to hold a temperature for a desired period.

- Press H.
- Using the Up/Down arrow keys enter the required hold time.
- Press H.
- Using the Up/Down arrow keys enter the required hold temperature.
- Press A to accept.

You will see the Hold indication is displayed which will countdown the hold duration.

To cancel, reduce the Hold time to 00 hours.

## **Temperature Set**

Using the Up or Down arrow keys allows you to adjust the set temperature. When you press either of these keys, you will see the word SET and the desired temperature.

Press A to accept.

## Holiday

The PRT-E has a holiday function. This allows you to enter a holiday setting. During a holiday, the thermostat will maintain the frost set temperature. At the end of your holiday, the thermostat will revert back to the programmed setting ensuring that your home is warm on your arrival.

- Press H three times (Until you see the suitcase).
- Using the Up/Down arrow keys enter the number of days holiday.
- Press A to accept.

The PRT-E will show a suitcase indicating the thermostat is in holiday mode. To cancel, reduce the Holiday duration to 00 days.

## Heat On / Off

**Frost Protect Mode:** Pressing the Power button once will place the thermostat in frost protect mode. In this mode, the thermostat will display the frost icon and will only turn the heating on should the room temperature drop below the set temperature (see page 14) Should the heating be turned on whilst in frost mode, the flame symbol will be displayed. To cancel the frost protect mode, press the On button.

**Thermostat Off:** To turn the thermostat off completely, press and hold the Off button. The display and heating output will be turned off. To turn the thermostat back on, press the On button.

## Factory Reset

The thermostat has a factory reset function. This will reset all settings back to their factory default. To perform a factory reset, follow these steps:

- Turn the thermostat off (See above).
- Press and hold the Power and Up arrow key until the LCD powers up. All of the icons will be displayed. When they have disappeared, the thermostat has been reset.

## Setting The Mode

The PRT-E has 4 modes, these are explained below:

<b>Mode No.</b>	<b>Mode explanation</b>
00	Non programmable mode with built in air sensor
01	Non programmable with remote sensor options
02	Programmable mode with built in air sensor
03	Programmable mode with remote sensor options

First select the best mode which suits your application, and then follow the steps below to setup the thermostat:

1. Turn off the thermostat by pressing and holding the Power button.
2. Press and hold the H key for 10 seconds.
3. Using the Up/Down keys, you should select the mode required.
4. Press A to accept.

## **THE FOLLOWING SETTINGS ARE OPTIONAL AND IN MOST CASES NEED NOT BE ADJUSTED**

### **Optional Features Explained**

**Feature 01 - Temperature Format:** This function allows you to select between °C and °F.

**Feature 02 – Switching Differential:** This function allows you to increase the switching differential of the thermostat. The default is 1°C which means that with a set temperature of 20°C, the thermostat will switch the heating on at 19°C and off at 20°C. With a 2°C differential, the heating will switch on at 18°C and off at 20°C.

**Feature 03 – Frost Protect:** You can set whether the thermostat will maintain the frost temperature when the thermostat display is turned off. As a default, this is enabled.

**Feature 04 – Frost Protect Temperature:** This is the temperature maintained when the thermostat is in frost mode. The range is 07 - 17°C. The default is 12°C and is suitable for almost all applications.

**Feature 05 – Output Delay:** To prevent rapid switching, an output delay can be entered. This can be set from 00-15 minutes. The default is 00 which means there is no delay.

**Feature 06 – Communication Address:** This setting is used when you have connected your thermostat to a network system. Each thermostat on your network must have a unique communication address. This can be set from 01-32.

**Feature 07 – Temperature Up/Down Limit:** This function allows you to limit the use of the up and down temperature arrow keys. This limit is also applicable when the thermostat is locked and so allows you to give others limited control over the heating system.

**Feature 08 – Sensor Selection:** This thermostat has a built in air sensor. In mode 00 and 02 (as described on page 13), the thermostat uses the built in air sensor and cannot be changed. In modes 01 and 03 you have the option to select from the following sensor options:

- 00 = Built in Air Sensor
- 01 = Remote Air Sensor
- 02 = Floor Sensor Only
- 03 = Floor Sensors & Built in Air Sensor
- 04 = Floor Sensor and Remote Air Sensor

**Feature 09 – Floor Limit:** When the thermostat is operating in mode 01 and 03 (as described on page 13) and function 08 is set to 02, 03 or 04, function 09 becomes available. You can then set the maximum floor temperature limit - 20-45°C (28°C default).

**Feature 10 – Optimum Start:** Optimum start will delay the start up of the heating system to the latest possible moment to avoid unnecessary heating, so that the dwelling is comfortably warm by the programmed time. The thermostat uses the rate of change (see below) setting to calculate how long the building needs to take to raise the building 1°C (with a rate of change of 20, the thermostat has calculated the building needs 20 minutes to raise the building 1°C).

**Feature 11 – Rate of Change:** For information only.

**Feature 12 – Weekday/Weekend or 7 Day Programming:** The thermostat offers two programming methods. Weekday/Weekend allows you to program 4 comfort levels for the weekday and 4 different comfort levels for the weekend. In 7 day program mode, each day has 4 comfort levels that can be programmed independently.

## Adjusting the Optional Settings

1. To access the configuration menu, turn off the thermostat by pressing and holding down the Power Button. Then, press and hold the Clock button until the display lights up.
2. The small number is the feature number, the large number is the setting value.
3. Use the clock button to cycle through the features.
4. Use the Up/Down keys to change the setting.
5. Press A to accept and store.

### Feature Table

Feature	Description	Setting
01	Temperature Format	00=°C 01=°F
02	Switching Differential	01-03°C 01°C Default
03	Frost Mode	00 = Enabled 01 = Disabled (00 = Default)

## Feature Table (continued)

Feature	Description	Setting
04	Frost Temperature	07-17°C (12°C Default)
05	Output Delay	00-15 Minutes (00 Default)
06	Communication ID	Set Unique Comms Address 01-32
07	Up/Down Temp Limit	00-10°C (00°C Default)
08	Sensor Selection	00 = Built In Air Sensor (Default) 01 = Remote Air Sensor 02 = Floor Sensor Only 03 = Floor Sensor and Built In Air Sensor 04 = Floor Sensor and Remote Air Sensor

## Feature Table (continued)

<b>Feature</b>	<b>Description</b>	<b>Setting</b>
09	Floor Limiting Sensor	20-45°C 28°C Default
10	Optimum Start	00-03 (00 hours default)
11	Rate of Change	Information only
12	Mode Select	00=Weekday/Weekend 01 = 7 day programming

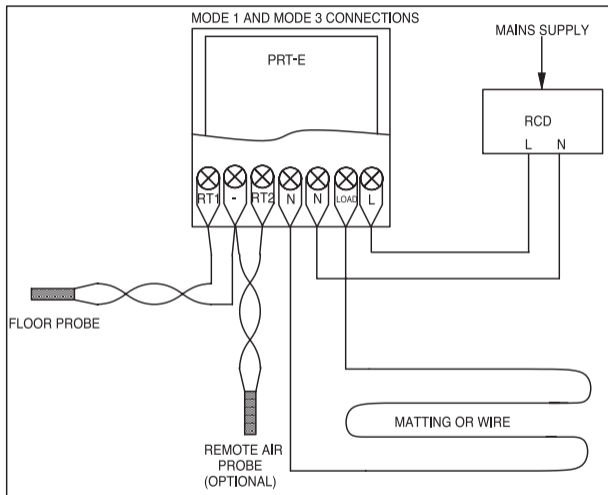

PRT-E TO UH3 CONNECTIONS

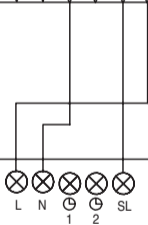
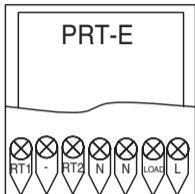

UH3



ZONE 1---8

**OPTION 1**

A remote air sensor can be connected between the RT2 and - terminals

**OPTION 2**

A remote floor sensor can be connected between the RT1 and - terminals

**OPTION 3**

Both remote air and floor sensors can be connected at the same time

**NOTE**

Sensor selection needs to set up in the feature menu during installation

Support Tel: 01254 870303